

LED Pendant

493126
INSTALLATION SHEET

START FROM HERE

- Make sure power is completely off at the fuse box.
- Have your fixture installed by a qualified licensed electrician
- Prepare everything in a clear area.
- Wear gloves at all times during this installation.
- Read instructions carefully before you start assembly.
- Keep this instruction sheet for future reference.

Technical Support: 1-855-855-8926

- 1.** Remove the fixture from its original packaging. Next, remove the mounting plate **(1c)** from the canopy **(2a)** by removing the decorative nuts **(2b)**. Attach the mounting plate **(1c)** to the electrical junction box **(1a)** using the two screws **(1d)** provided in the hardware package.
- 2.** To change fixture height, shorten or lengthen wire by removing set screw **(2c)** from canopy **(2a)** and push or pull wire to your desired length. Secure set screw **(2c)** in canopy **(2a)** to lock wire in place.
- 3.** You are now ready to mount the canopy **(2a)** to the mounting plate **(1c)**. First connect all wires **(1b)** correctly black to black "L", white to white "N" and the ground wire with provided marrettes from the hardware package. Align the threaded studs **(1e)** with the holes on the surface of the canopy **(2a)**. Next, push the canopy **(2a)** up towards the mounting plate **(1c)** and thread on the decorative nuts **(2b)** on the threaded studs **(1e)**. This will secure the canopy to the mounting plate.
- 4.** Install the bulb (bulb not included) to the fixture. You have now completed the installation of your fixture, enjoy.

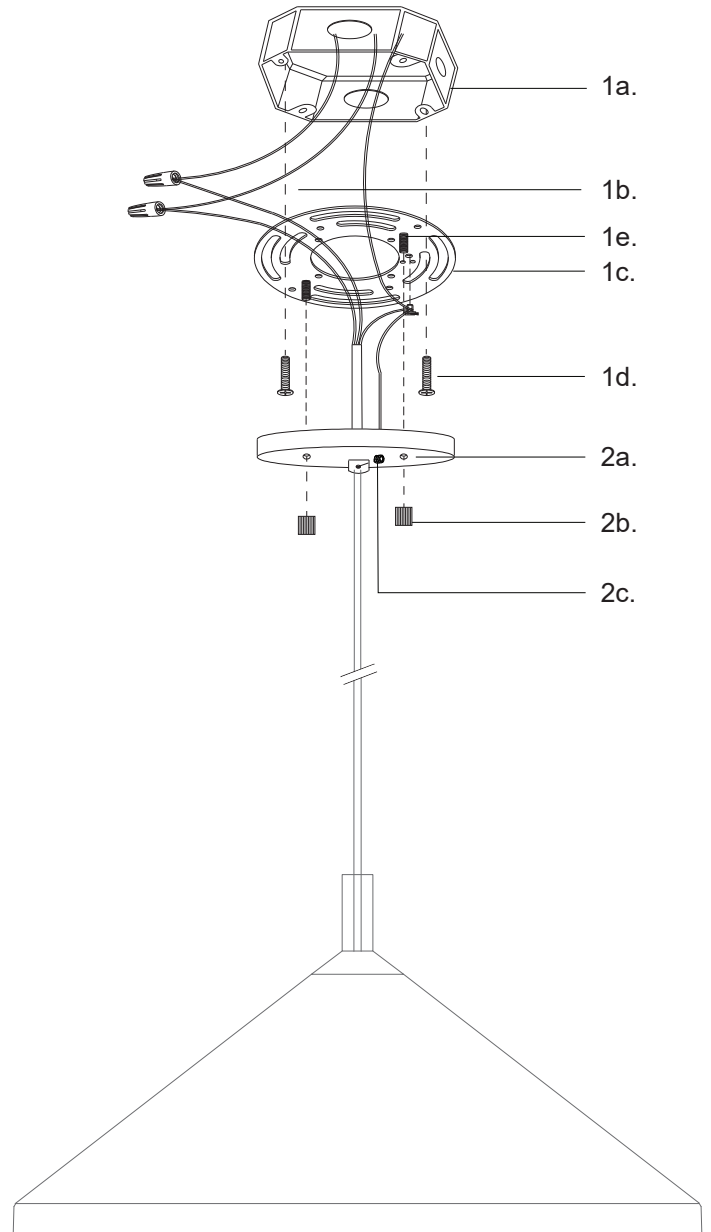

KUZCO

19054 28th Avenue Surrey, BC Canada V3Z 6M3
T: 604 538 7162 TF: 1-855 85 KUZCO F: 604 538 7196
W: kuzcolighting.com
20190117